

## BI-680 Industrial Dissolved Oxygen Controller

# USER MANUAL

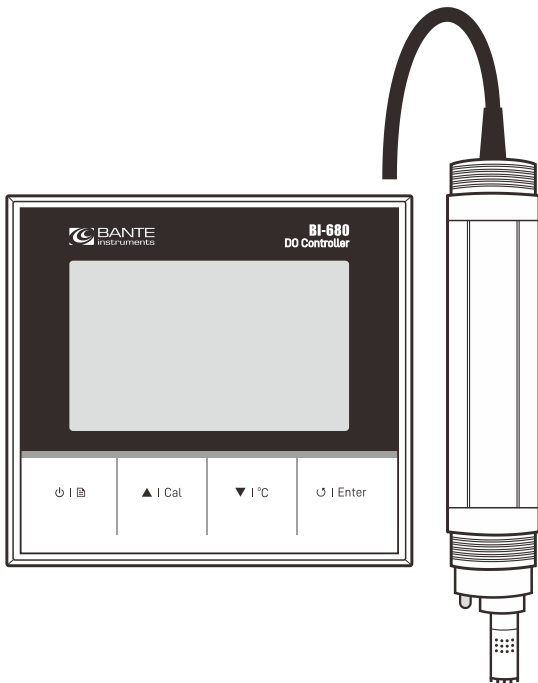

## Introduction

Thank you for selecting the BI-680 dissolved oxygen controller. This user manual provides a step-by-step guide to help you operate the meter, please carefully read the following instructions before use.

### Environmental Conditions

Before the installation, ensure that current environmental conditions meet the following requirements.

- Relative humidity is less than 80%
- Ambient temperature between 5°C (41°F) and 50°C (122°F)
- No potential electromagnetic interference
- No corrosive gas exists

### Packing List

The following list describes all components of the meter. If any items are missing or damaged, contact the supplier immediately.

---

BI-680 dissolved oxygen controller

---

IE-80T industrial dissolved oxygen electrode

---

Membrane cap and electrolyte solution

---

## Installation

### Safety Warning

- BI-680 meter shall be installed and operated only in the manner specified in this user manual.
- Only skilled, trained or authorized person should carry out installation, setup and operation of meter.



- The rear panel of meter has two screw terminals for connecting the 24V DC power supply. Make sure to cut off the main power before installation and maintenance.
- Once the power supply cable is connected to the meter, DO NOT touch any screw terminals.

### Installing the Meter

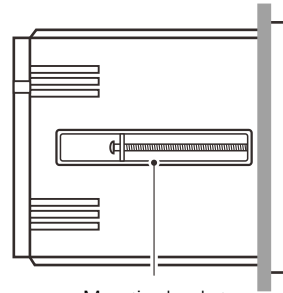
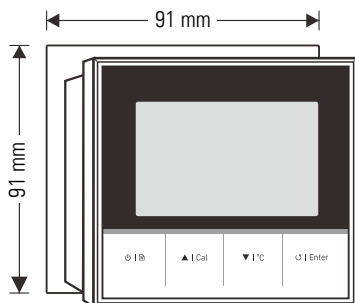

Mounting bracket

- 1.1 Cut out a square hole approximately 91 × 91 mm (3.58 × 3.58 in.) in the mounting panel.
- 1.2 Remove the mounting bracket, place the meter into the square hole.
- 1.3 Replace the mounting bracket and push the meter forward until it is fully seated on the mounting plate.

### Installing the Electrode

- 2.1 Take out the dissolved oxygen electrode from the packaging. Unscrew the membrane cap from the bottom of the electrode, rinse the inside and outside with distilled water and blot dry.
- 2.2 Fill the membrane cap halfway with electrolyte solution.

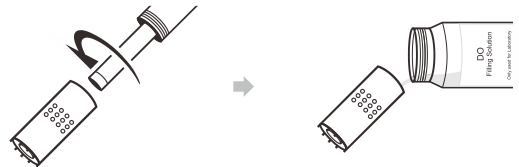

- 2.3 Screw membrane cap back onto the electrode. Some electrolyte solution will overflow during this process.
- 2.4 Check the electrode, ensure that no air bubbles are trapped in the electrolyte solution and membrane is not creased or damaged.

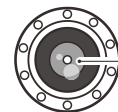

Remove air bubbles

- 2.5 Wrap Teflon tape to the electrode body threads.
- 2.6 Insert the electrode into the mounting position and slowly turn clockwise until secure. Hand tighten the electrode to prevent liquid leakage.

## Connection

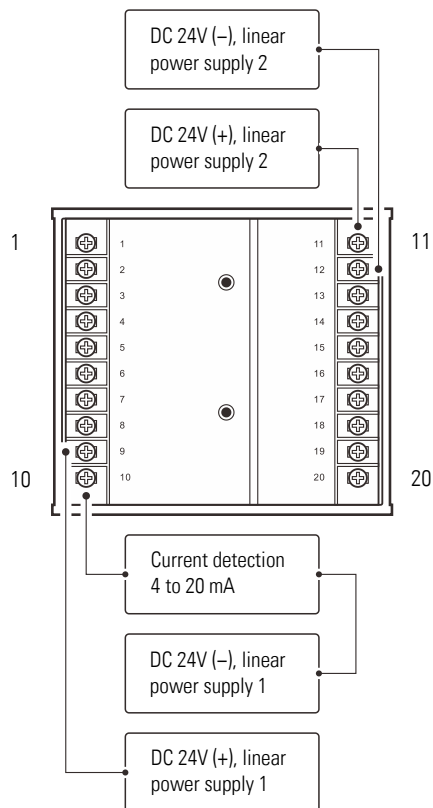

No.	Terminal	Description
1	DO (-)	Dissolved oxygen input (-)
2	DO (+)	Dissolved oxygen input (+)
3	---	No connection
4	---	No connection
5	TC (-)	Temperature input (-)
6	TC (+)	Temperature input (+)
7	485 (B)	RS485 signal output (B)
8	485 (A)	RS485 signal output (A)
9	DC 24 (+)	DC 24V (+), linear power supply 1
10	DC 24 (-)	DC 24V (-), linear power supply 1 4 to 20 mA analog output
11	GND	Earth ground
12	DC 24 (+)	DC 24V (+), linear power supply 2

13	DC 24 (-)	DC 24V (-), linear power supply 2
14	NC2	Relay resting position (NC2)
15	NO2	Relay working position (NO2)
16	COM2	Relay common (COM2)
17	NC1	Relay resting position (NC1)
18	NO1	Relay working position (NO1)
19	COM1	Relay common (COM1)
20	---	No connection

## Meter Overview

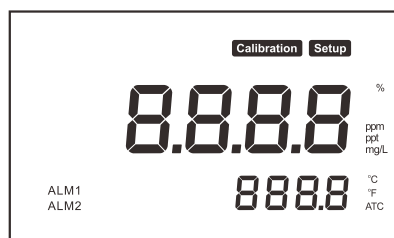

## Display

Icon	Description
Calibration	Indicates that the meter is in the calibration mode
Setup	Indicates that the meter is in the setup mode
ATC	Indicates that the automatic temperature compensation is enabled
ALM1	Indicates the measurement exceeded the high limit
ALM2	Indicates the measurement exceeded the low limit

## Keypad

Key	Function
⏻   🏠	<ul style="list-style-type: none"> <li>Switch the meter on or off</li> <li>Press and hold the key to enter the setup menu</li> <li>Exit the calibration, settings and return to the measurement mode</li> </ul>
▲   Cal	<ul style="list-style-type: none"> <li>Start calibration</li> <li>Increase value or scroll up the menu items</li> </ul>
▼   °C	<ul style="list-style-type: none"> <li>Set the temperature</li> <li>Decrease value or scroll down the menu items</li> </ul>
↻   Enter	<ul style="list-style-type: none"> <li>Select the measurement mode</li> <li>Confirm the calibration, setting or displayed option</li> </ul>

## Meter Setup

The BI-680 meter contains an integrated setup menu for customizing the displayed option to meet measurement requirement. The following table describes the functions of each menu item.

Menu Item	Option and Description
SALC	<b>Salinity Coefficient</b> Set the salinity compensation coefficient of sample.
	00 0 to 35 g/L (default 0 g/L)
PRES	<b>Pressure Coefficient</b> Set the barometric pressure coefficient according to the local altitude (refer to page 4).
	760 450 to 850 mmHg (default 760 mmHg)
CAL	<b>Calibration Points</b> Set the number of calibration points.
	1 1 point (default)
	2 2 points
UNIT	<b>Measurement Unit</b> Set the default measurement unit.
	mg/L Milligrams per liter (default)
	ppm Parts per million
	% Percentage saturation
	°C Degrees Celsius (default)
	°F Degrees Fahrenheit
AL-L	<b>Low Alarm Limit</b> Setting range: 0.00 to 20.00 mg/L (default 4.00)
AL-H	<b>High Alarm Limit</b> Setting range: 20.00 to 0.00 mg/L (default 10.00)
HYS	<b>Hysteresis Value</b> Setting range: 0.01 to 0.10 mg/L (default 0.1)
AO-L	<b>Analog Output (Low)</b> Setting range: 0.00 to 20.00 mg/L (default 4.00)
AO-H	<b>Analog Output (High)</b> Setting range: 20.00 to 0.00 mg/L (default 10.00)

### Factory Reset

Reset the meter to factory default settings. Note, the meter must be recalibrated.

RS485

YES	Enable
NO	Disable (default)



- If the high or low alarm is enabled, the meter will be activated when the measurement exceeds specified limit. Note, this option can not enter the same values.
- If the hysteresis is enabled, the meter will prevent rapid contact switching when the measurement is fluctuating near the set point. For example, you have set the high alarm at 20 mg/L and hysteresis value at 0.1 mg/L. When the measurement overshoots the 20.1 mg/L, the meter will activate an external device. When the measurement drops to 19.9 mg/L, the device will switch off.
- The default RS485 communication is 4.00 to 10.00 mg/L corresponds to the 4.00 to 20.00 mA.

### Setting a Default Option

- In the measurement mode, press and hold the key to enter the setup menu.
- Press the / key to select a menu item, press the **Enter** key to confirm.



- Press the / key to select an option or set a value, press the **Enter** key to save.



To exit the setup menu without saving changes, press the key.

The following table describes the relationship between the altitude and barometric pressure, make sure to set a compatible parameter before the calibration and measurement.

Altitude (m)	kPa	mmHg	Altitude (m)	kPa	mmHg
0	101.3	760	1600	82.9	622
100	100.1	750	1700	81.9	614
200	98.8	741	1800	80.9	607
300	97.6	732	1900	79.9	599
400	96.4	723	2000	78.9	592
500	95.2	714	2100	77.9	584
600	94.0	705	2200	76.9	577
700	92.8	696	2300	76.0	570
800	91.7	688	2400	75.0	563
900	90.5	679	2500	74.1	556
1000	89.4	671	2600	73.2	549
1100	88.3	662	2700	72.3	542
1200	87.2	654	2800	71.4	536
1300	86.1	646	2900	70.5	529
1400	85.0	638	3000	69.6	522
1500	84.0	630	3100	68.7	515

## Temperature Compensation

The BI-680 meter is supplied with an industrial dissolved oxygen electrode. When the wires of electrode are connected to the meter, the display will show ATC icon immediately. The meter is now switched to the automatic temperature compensation mode.

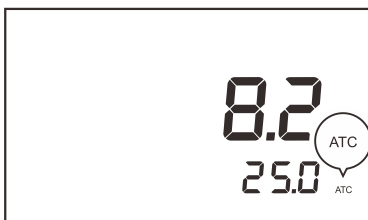

## Temperature Calibration

During the measurement, if the measured temperature reading differs from that of an accurate thermometer, the electrode needs to be calibrated.

1. Place the electrode into a solution with a known accurate temperature.
2. Press the **°C** key to enter the temperature setting.
3. Press the **▲ / ▼** key to modify the temperature value.
4. Press the **Enter** key to save.



## Dissolved Oxygen Calibration

The BI-680 meter is able to perform either 1 or 2 points calibration. For single point calibration, we recommend that you perform 100% saturation calibration in the air-saturated water. If the 2 points calibration is selected, the zero oxygen solution needs to be used.

### Single Point Calibration

- 1.1 Make sure that you have selected 1 point calibration in the setup menu.
- 1.2 Press the **Cal** key, the display shows 100%/CAL1.

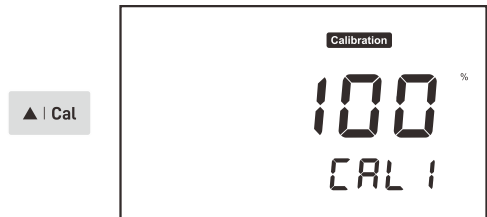

- 1.3 Hold the dissolved oxygen electrode in the air at 100% relative humidity or place the electrode into the air-saturated water for about 10 minutes.

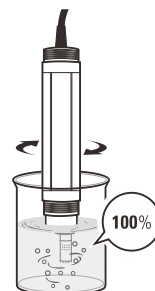

Press the **Enter** key to begin the calibration.

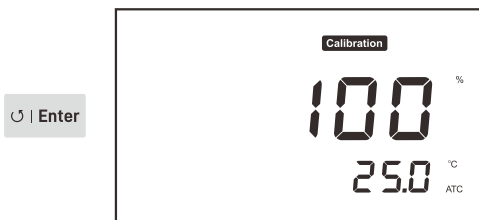

- 1.4 When the reading has stabilized, the meter will show *End* and return to the measurement mode.

## 2 Points Calibration

- 2.1 Ensure that you have selected 2 points calibration in the setup menu.
- 2.2 Repeat steps 1.2 and 1.3 above. When the first calibration point is completed, the display will show 0%/CAL2, the meter prompts you to continue with second point calibration.

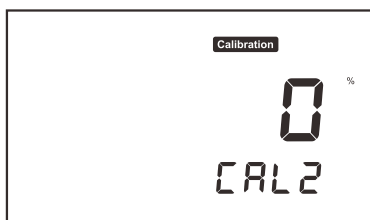

- 2.3 Place the dissolved oxygen electrode into the zero oxygen solution for about 10 minutes.

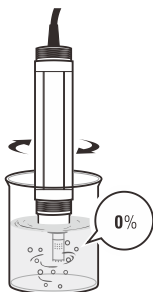

Press the **Enter** key to begin the calibration.

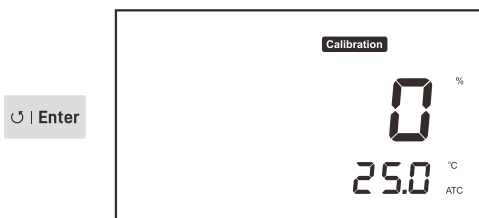

- 2.4 When the reading has stabilized, the meter will show *End*. Calibration is completed.

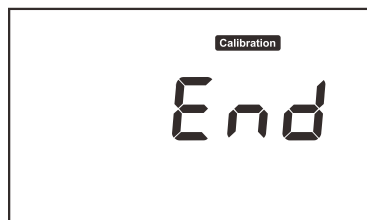

- Performing a percentage saturation calibration will calibrate the corresponding mg/L or ppm concentration value simultaneously.
- To exit the calibration without saving calibrated values, press the key.

## Measurement

The BI-680 meter can be used to measure the water, wastewater, brine and other liquids. If your sample is seawater or water containing large amounts of salt, make sure to set the salinity coefficient before measurement. Some gas and steam such as chloride, sulfur dioxide, sulfureted hydrogen and carbon dioxide can permeate the membrane via diffusion. Their existence will influence the measurements. If the sample contains solvent, grease, sulfide and alga, the membrane will be damaged or eroded.

- Press the key to select the mg/L or % saturation measurement mode.
- Set the barometric pressure and salinity coefficient in the setup menu.
- Place the electrode into the sample. Wait for the measurement to stabilize.

## Communication

The BI-680 meter uses a standard Modbus-RTU protocol. All of the data are character type (2 bytes). The response data ranges between -32767 to 32767, hexadecimal.

### PC Command

Definition	Length of Byte	Data
ID address	1	0 × 03
Command	1	0 × 03
Start address	2	0 × 0001
Data number	2	0 × 0002
CRC16	2	0 × 9429

### Meter Response

Definition	Length of Byte	Data
ID address	1	0 × 03
Command	1	0 × 03
Data Length	1	0 × 0002
Data	N	0 × 02 0 × BC
CRC16	2	0 × E539

- If the response is 01 indicating the command is error.
- If the response is 02 indicating the address is incorrect.
- If the response is 03 indicating the byte length is incorrect.

Command 03: Read the data from the measurement

Command 04: Read the data from the setting

- ID: 0 × 03 (Fixed)
- 03: Definition  
Address:  
0 × 0000 - Dissolved oxygen reading  
0 × 0001 - Measurement unit  
0 × 0002 - Temperature (Reading × 0.1)
- 04: Definition  
Address:  
0 × 0000 - Read the low alarm limit  
0 × 0001 - Read the high alarm limit  
0 × 0002 - 4.00 mA correspond to the dissolved oxygen value  
0 × 0003 - 20.00 mA correspond to the dissolved oxygen value

Measurement Unit Response:

- 0 × 0001: mg/L
- 0 × 0002: ppm
- 0 × 0003: %

For Example (Hexadecimal):

```
PC send: 03 03 00 00 00 02 C5 E9 (Read the DO)
Response: 03 03 02 02 BC C1 55 (700)
PC send: 03 03 00 01 00 02 94 29 (Read the unit)
Response: 03 03 02 00 01 00 44 (mg/L)
```

The result will show 7.00 mg/L (700 × 0.01 mg/L)

## Electrode Maintenance

In order to maintain an accurate measurement, the dissolved oxygen electrode needs cleaning and regular maintenance.

- Rinse the electrode with clear water to remove deposits.
- If necessary, fill the electrolyte solution to membrane cap.
- If you do not use the electrode for long periods, screw off the membrane cap, rinse the electrode anode, cathode, membrane cap with distilled water and blot dry. Install the electrode and store dry.



Cathode Anode

## Appendix

### Troubleshooting

Fault	Cause and Corrective Action
Screen shows - - - -	Dissolved oxygen electrode does not connect to the meter or measured value is out of range.
Drifting erratic readings	Check whether the membrane cap is contaminated or the electrolyte solution is depleted.
Screen shows E r r	Electrode is broken. Replace the dissolved oxygen electrode.

### Preparation of Air-Saturated Water

Use an air-pump to blow air into distilled water at least 1 hour, while stirring the solution.

### Preparation of Zero Oxygen Solution

Dissolve 500 mg of the sodium sulfate (Na<sub>2</sub>SO<sub>3</sub>) reagent and a small amount of cobalt (II) chloride hexahydrate (CoCl<sub>2</sub> • 6H<sub>2</sub>O) in the 250 ml distilled water, mix the solution until reagent is completely dissolved.

## Optional Accessories

Order Code	Description
IE-80T	Dissolved oxygen electrode, range: 0 to 20 mg/L
DO-MEM	Membrane cap, 2 PCS/set
DO-ES	Electrolyte solution, 30 ml
DO-ZO	Zero oxygen solution, 100 ml

## Meter Specifications

Model	BI-680
<b>Dissolved Oxygen</b>	
Range	0.00 to 20.00 mg/L
Resolution	0.01 mg/L
Accuracy	±0.5 mg/L
<b>% Saturation</b>	
Range	0.0 to 200.0%
Resolution	0.1%
Accuracy	±2.0%
<b>Temperature</b>	
Range	0 to 50°C (32 to 122°F)
Resolution	0.1°C (0.1°F)
Accuracy	±1°C (±1.8°F)
Calibration Point	1 point
<b>Communication</b>	
Signal Output	4 to 20 mA
Low or High Alarm	0.00 to 20.00 mg/L
Load	500 Ω
Communication Interface	RS485
<b>Other Specifications</b>	
Operating Temperature	5 to 50°C (41 to 122°F)
Storage Temperature	0 to 60°C (32 to 140°F)
Relative Humidity	< 80% (non-condensing)
Display	LCD, 70 × 45 mm (2.9 × 1.7 in.)
Power Requirements	DC 24V
Dimensions	96 (L) × 96 (W) × 75 (H) mm, (3.7 × 3.7 × 2.9 in.)
Weight	350 g (12.3 oz.)

## Disposal

This product is required to comply with the European Union's Waste Electrical and Electronic Equipment (WEEE) Directive 2002/96/EC and may not be disposed of in domestic waste. Please dispose of product in accordance with local regulations at the collecting point specified for electrical and electronic equipment.



## Warranty

The warranty period for meter is one year from the date of shipment. Above warranty does not cover the electrode and electrolyte solution.

Out of warranty products will be repaired on a charged basis.

The warranty on your meter shall not apply to defects resulting from:

- Improper or inadequate maintenance by customer
- Unauthorized modification or misuse
- Operation outside of the environment specifications of the products

For more information, please contact the supplier.



Office: 4715 Castlewood St., Sugar land, TX 77479, USA

Tel: (+1) 346-762-7358

E-mail: banteinstruments@yahoo.com

Factory: 2185 Laifang Rd., Shanghai 201615, China

Tel: (+86) 21-6404-1598

E-mail: banteinstrument@hotmail.com

 [www.bante-china.com](http://www.bante-china.com)



The information in this document is subject to change without notice.  
Copyright © Bante Instruments Inc, 2022. All rights reserved.